

Diffusore in policarbonato di elevata qualità con sistema click, resistente ai raggi UV e agli urti.  
 Diffusore trasparente o acidato.  
 Led Strip.  
 Corretta dissipazione del calore per una lunga durata dei led.  
 Esempi di applicazioni:  
 Per cucine e sottopensili; Soffitti, mensole, scaffali; Soffitti in cartongesso; Interior lighting design; Illuminazione lineare pavimento (con Led IP54); Illuminazione per interni.

Polycarbonate high-quality diffuser with system clicks, UV resistant and shock.  
 Clear or satin diffuser.  
 Led Strip high yield.  
 Heat dissipation for long life of LEDs.  
 Examples of applications:  
 For kitchens and roofs; Ceiling, shelves, racks; Plaster Ceiling; Interior lighting design; Linear Lighting floor (with LED IP54); Interiors lighting.

Hochwertiges Polykarbonat Diffuser mit Klicks System, UV-beständig und Schock.  
 Klar oder gefrostet Diffusor.  
 Led-Streifen hohe Leistung.  
 Wärmeabgabe für eine lange Lebensdauer der LEDs.  
 Beispiele für Anwendungen:  
 Für die Küche und Hängend; Decken, Regalen; Gipskartondecken; Innenbeleuchtung Design; Linear Lighting Stock (mit LED IP54); Innenbeleuchtung.

Diffuseur en polycarbonate de haute qualité avec système Clics, résistant aux UV et aux chocs.  
 Diffuseur transparent ou mat.  
 Led bande à haut rendement.  
 Dissipation de la chaleur pour une longue vie de LED.  
 Exemples d'applications:  
 Pour les cuisines et les pendants; Plafonds et étagères; Plafonds en Placoplatre; L'éclairage intérieur de design; Rez-éclairage linéaire (avec LED IP54); Éclairage intérieur.

Policarbonato de alta calidad clics del sistema, los rayos UV y el shock.  
 Transparente y difusor esmerilado.  
 Led Strip.  
 Disipación de calor para una larga vida de los LEDs.  
 Ejemplos de aplicaciones:  
 Bajo el techo de las cocinas; Techos, repisa, estantes; Techos de yeso; La iluminación interior de diseño; Planta de iluminación lineal (con LED IP54); Iluminación interior.

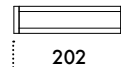
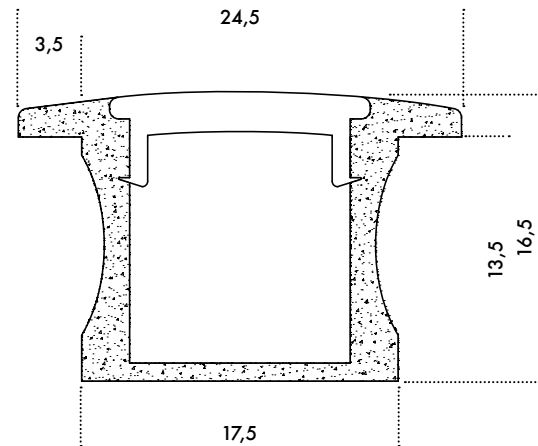

struttura - surface finish Struktur - monture - estructura	diffusore - diffuser - Diffusor diffuseur - difusor		W	articolo - article - Artikel article - articulo
AA	P2	P4	1,44	248 202 2
ALLUMINIO ANODIZZATO	TRASPARENTE	SATINATO		

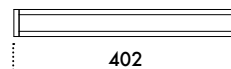

struttura - surface finish Struktur - monture - estructura	diffusore - diffuser - Diffusor diffuseur - difusor		W	articolo - article - Artikel article - articulo
AA	P2	P4	2,88	248 402 3
ALLUMINIO ANODIZZATO	TRASPARENTE	SATINATO		

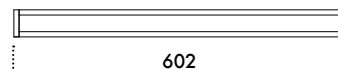

struttura - surface finish Struktur - monture - estructura	diffusore - diffuser - Diffusor diffuseur - difusor		W	articolo - article - Artikel article - articulo
AA	P2	P4	4,32	248 602 4
ALLUMINIO ANODIZZATO	TRASPARENTE	SATINATO		

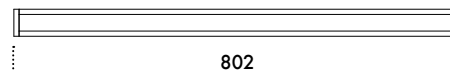

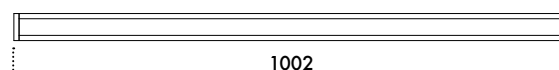

struttura - surface finish Struktur - monture - estructura	diffusore - diffuser - Diffusor diffuseur - difusor		W	articolo - article - Artikel article - articulo
AA	P2	P4	5,76	248 802 6
ALLUMINIO ANODIZZATO	TRASPARENTE	SATINATO		



struttura - surface finish Struktur - monture - estructura	diffusore - diffuser - Diffusor diffuseur - difusor		W	articolo - article - Artikel article - articulo
AA	P2	P4	7,2	248 1002 7
ALLUMINIO ANODIZZATO	TRASPARENTE	SATINATO		







CLASSE III  
 DRIVER  
 A  
 RICHIESTA  
 0,50 mt  
 0,052 Kg  
 0,098 Kg  
 0,145 Kg  
 0,192 Kg  
 0,240 Kg



**Colori Ral e misure personalizzate su richiesta**

RAL colors and custom sizes on request

RAL-Farben und Sondergrößen auf Anfrage

Les couleurs RAL et les formats personnalisés sur demande

RAL colores y tamaños personalizados por encargo



ACCESSORI - ACCESSORIES - ZUBEHÖR - ACCESSOIRES - ACCESORIOS

